



QUICK START GUIDE

Tft60-399



NY Thermal Inc.
 Tel: (506) 657-6000
 Toll Free: 1-800-688-2575
 Fax: 1-506-432-1135
 Web: www.ntiboilertech.com
 Email: info@nythermal.com



Line Voltage Wiring

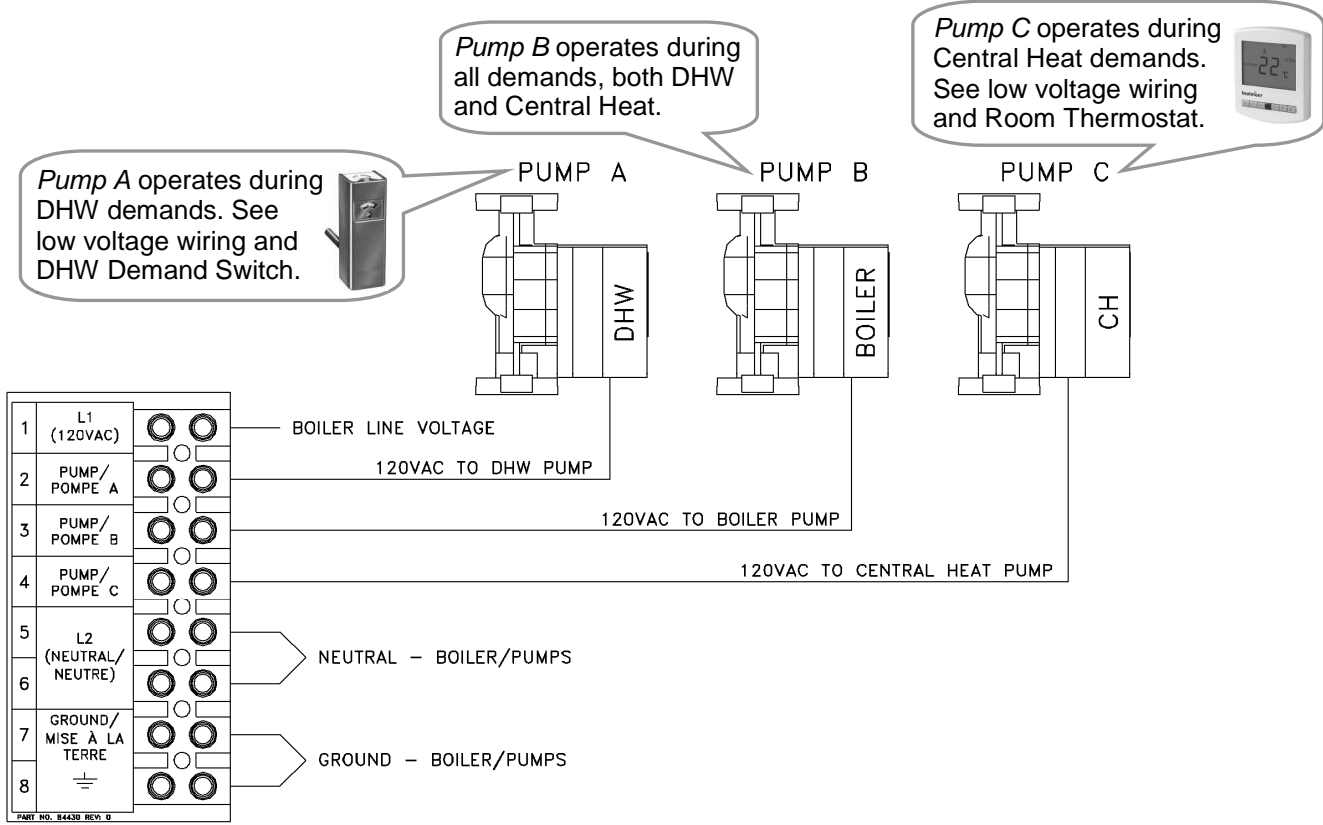

Low Voltage Wiring

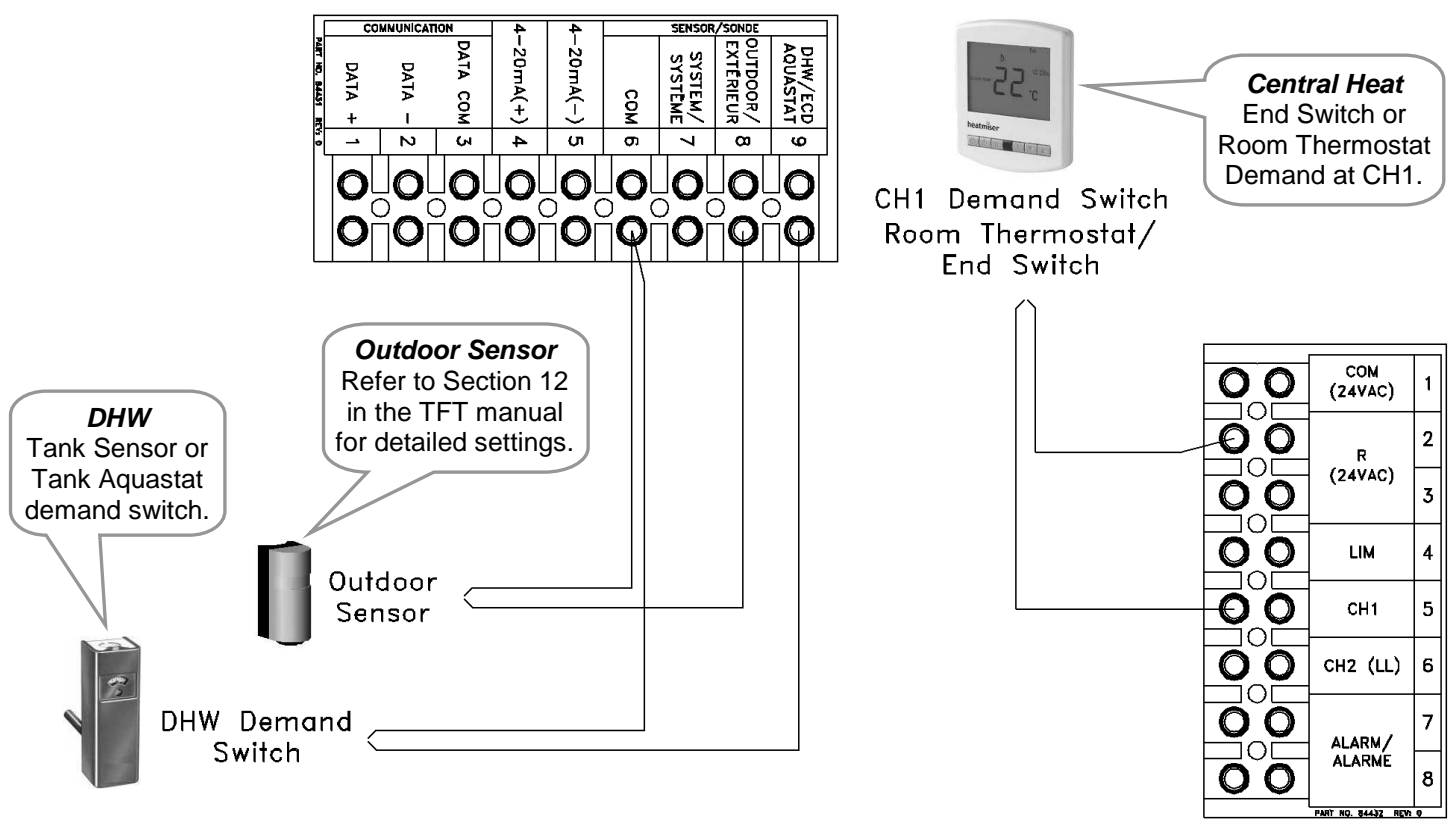

Navigating the Touch Screen Display

1 **Date/Time**

2

3 **Touch to return to Home screen**

4 **Home** **Summary**

5 **Config Menu**

6 **Change settings in a Config Group by selecting it from the Configuration Menu.**

Central Heat Settings

1

2 **LCI = CH1 Thermostat input. See manual for options. ► Next Page.**

3 **Change the default Setpoint to match the Heating System Type (see table below).**

Heating System Type	Application	Temp Ranges
Fin Tube Baseboard	High Temp	160F - 190F
Cast Iron Radiators	Medium Temp	135F - 155F
In Floor Radiant	Low Temp	100F - 130F

* It is the Installer's responsibility to choose an appropriate setpoint.

4 **Touch to return to previous screen**

Return to the Config Menu once settings have been changed.

Outdoor Reset Settings

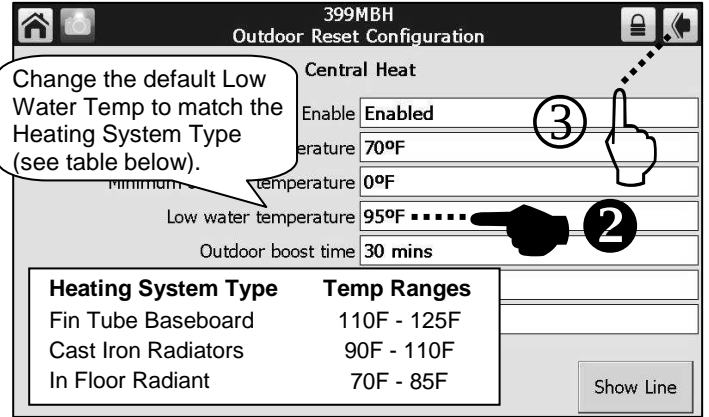
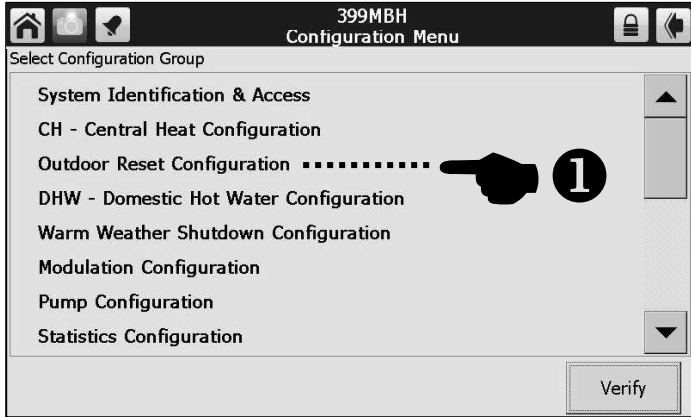

Domestic Hot Water Settings

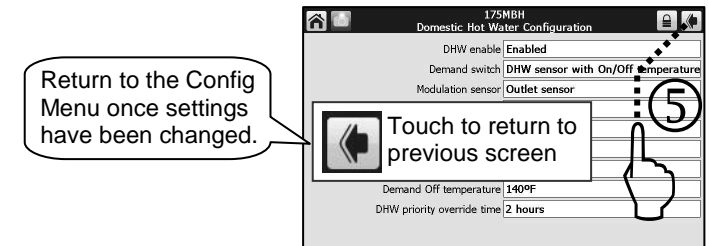
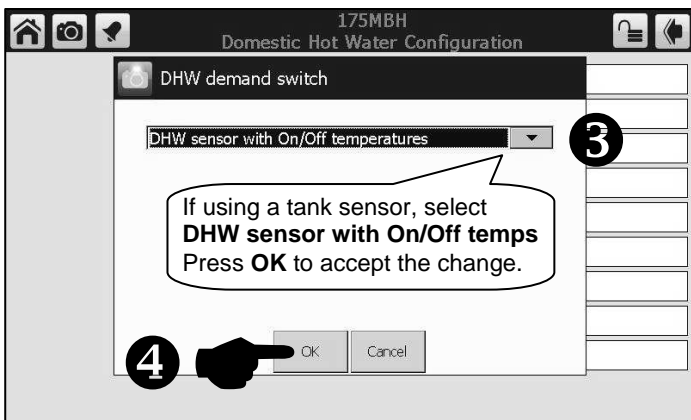
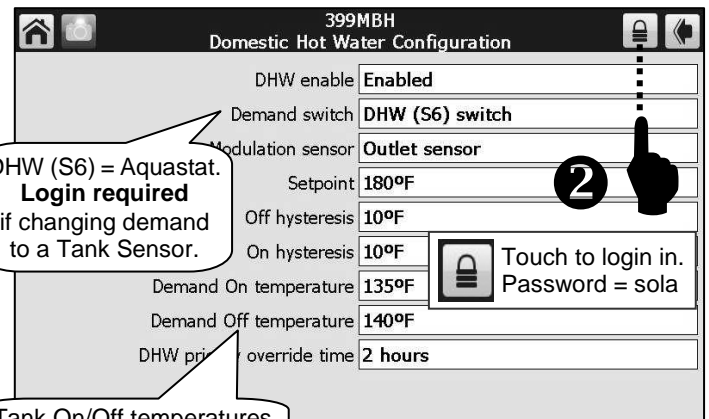
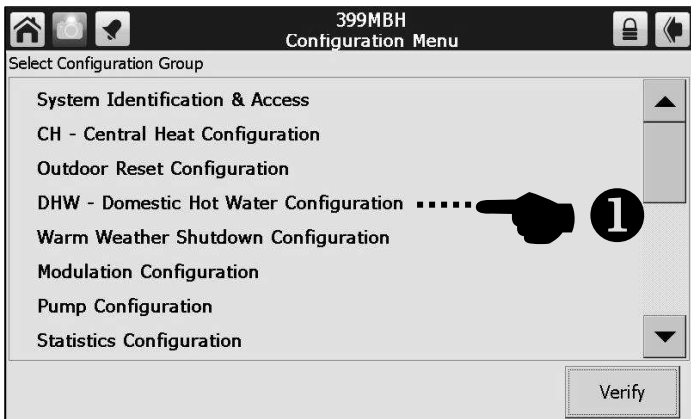

Warm Weather Shutdown Settings

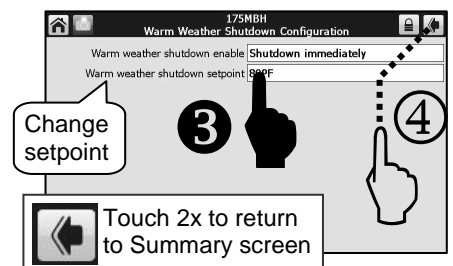
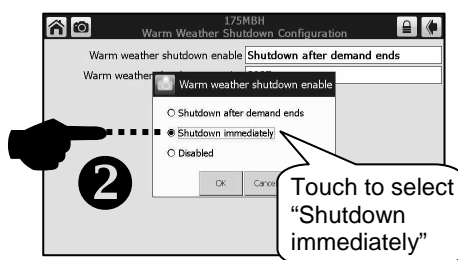
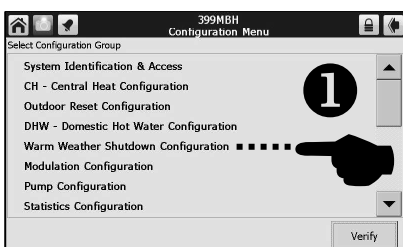

Tft60-110 Connections

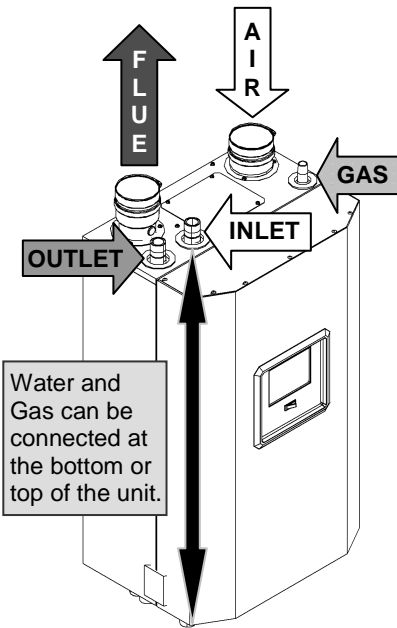

Connections Tft155-250

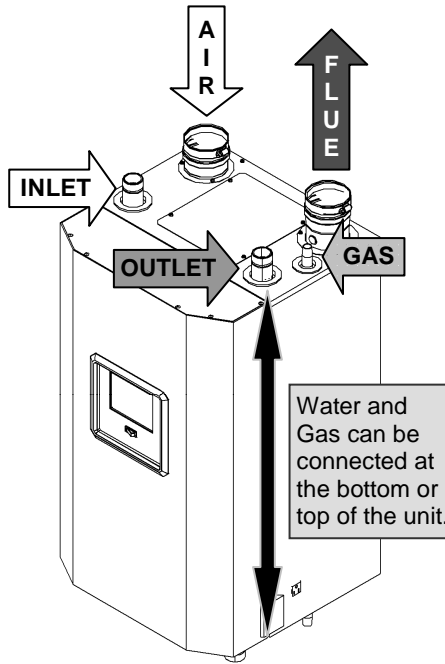

Tft300-399 Connections

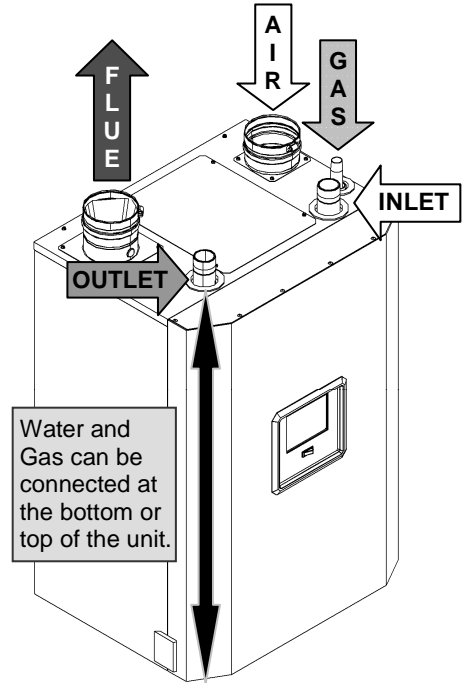

Wall Mounting | Common

